

SIMRAD

S3009 Navigation Echo Sounder

User Manual

ENGLISH



Preface

Disclaimer

As Navico is continuously improving this product, we retain the right to make changes to the product at any time which may not be reflected in this version of the manual. Please contact your nearest distributor if you require any further assistance.

It is the owner's sole responsibility to install and use the equipment in a manner that will not cause accidents, personal injury or property damage. The user of this product is solely responsible for observing maritime safety practices.

NAVICO HOLDING AS AND ITS SUBSIDIARIES, BRANCHES AND AFFILIATES DISCLAIM ALL LIABILITY FOR ANY USE OF THIS PRODUCT IN A WAY THAT MAY CAUSE ACCIDENTS, DAMAGE OR THAT MAY VIOLATE THE LAW.

This manual represents the product as at the time of printing. Navico Holding AS and its subsidiaries, branches and affiliates reserve the right to make changes to specifications without notice.

Governing language

This statement, any instruction manuals, user guides and other information relating to the product (Documentation) may be translated to, or has been translated from, another language (Translation). In the event of any conflict between any Translation of the Documentation, the English language version of the Documentation will be the official version of the Documentation.

Copyright

Copyright © 2018 Navico Holding AS.

Warranty

The warranty card is supplied as a separate document. In case of any queries, refer to the brand website of your unit or system: www.navico.com/commercial.

Compliance statements

Regulatory compliance

Navico declare under our sole responsibility that the S3009 conforms with the requirements of:

- the requirements of level 2 devices of the Radio communications (Electromagnetic Compatibility) standard 2008 - **RCM**
- the European Council Directive 2014/90/EU on Marine Equipment modified by Commissioning Directive (EU) 2017/306 - **Wheelmark**

All compliance documents are available on the product's section on the following website: www.navico.com/commercial.

Technical compliance

The S3009 meets the requirements of the following standards:

- NMEA 0183/IEC61162-1 ed.5
- NMEA 2000/IEC61162-3
- ISO 9875:2000/Cor 1:2006
- IEC62288 ed.2
- IEC60945 ed.4

About this manual

Important text conventions

Important text that requires special attention from the reader is emphasized as follows:

→ **Note:** Used to draw the reader's attention to a comment or some important information.

⚠ **Warning:** Used when it is necessary to warn personnel that they should proceed carefully to prevent risk of injury and/or damage to equipment/personnel.

Intended audience

This manual is written for system operators and installers. It assumes that the user has basic knowledge of echosounders, and assumes some knowledge and skills relevant to installation of transducers and echosounder equipment.

Software versions

You can view the software version from the About dialog:

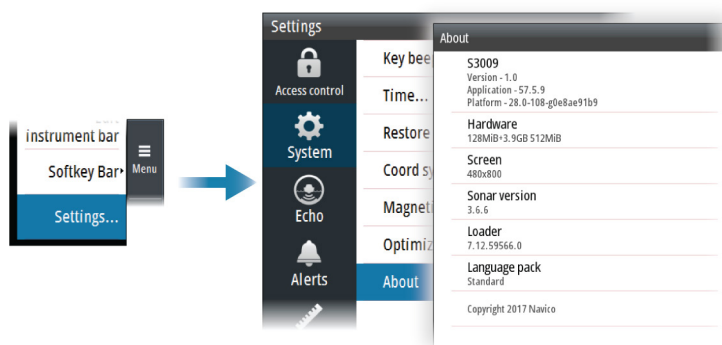

→ **Note:** The image above is an example only.

The manual will continuously be updated to match new software releases. The latest available manual version can be downloaded from the product website on: www.navico.com/commercial.

Change log

Part no	Date	Approved by
988-12043-001	4. Jan 2018	Jarl Gaute Vartdal
	First version	

Viewing the manual on the screen

The PDF viewer included in the unit makes it possible to read the manuals and other PDF files on the screen. The manuals can be read from a card inserted in the card reader or copied to the unit's internal memory.

Use the keys to maneuver in the PDF file as described below:

- Scroll pages
Use the rotary knob.
- Zoom in/out
Use the + and - keys.
- Maneuver on a page that is larger than the display area
Use the arrow keys.
- Exit the PDF viewer
Use the Exit key.

Trademarks

Navico® is a registered trademark of Navico.

Simrad® is used by license from Kongsberg.

NMEA® and NMEA 2000® are registered trademarks of the National Marine Electronics Association.

SD™ and microSD™ are trademarks or registered trademarks of SD-3C, LLC in the United States, other countries or both.

Contents

8	Introduction
8	The S3009 Navigation Echo Sounder system
8	System components
8	System examples
9	The user interface
9	Front panel and keys
10	The main panel
10	Softkeys
11	The menu system
11	On-screen keyboard
12	Basic operation
12	Turning the system on and off
12	Adjusting display brilliance
12	Acknowledging alerts
12	Adjusting depth settings
13	Zooming the image
13	Using the cursor on the image
14	Viewing the depth history
15	Setting up the echosounder image
15	Setting the range
15	Adjusting color and gain settings
16	Display time
16	Optional image items
16	Advanced options
18	Panel setup
18	Selecting transducer source
18	Split screen options
19	Show or hide the softkey bar
19	Edit the content of the Instrument bar
20	Advanced options
20	Recording depth data
20	Managing files
20	Simulator
21	Data logging
21	Depth log
21	Alert log
21	NMEA 0183 data log
21	Exporting the log files
22	The alert system
22	Type of alerts
22	Alert notifications
23	The Alerts dialog
23	Alphabetic alert list
24	Mounting
24	S3009 Control unit
25	Transducers
25	S5100 echosounder module

26	Wiring
26	Guidelines
26	System examples
27	Transducer wiring
32	Power wiring
34	Ethernet wiring
34	NMEA 0183 wiring
35	NMEA 2000 wiring
36	External alarm wiring
38	Software setup
38	Software setup sequence
38	Accessing the settings dialog
38	Access control
38	System settings
39	Echo settings
41	Units settings
41	Network settings
45	Maintenance
45	Preventive maintenance
45	Cleaning the display unit
45	Cleaning the media port door
45	Checking the keys
45	Checking the connectors
45	Software upgrades
46	Backing up your system data
47	Appendix
47	Menu overview
49	Dimensional drawings
51	Supported data
54	Technical specifications

1

Introduction

The S3009 Navigation Echo Sounder system

The S3009 Navigation Echo Sounder system is a type approved echosounder system conforming to the International Maritime Organization (IMO) requirements for equipment installed on vessels that are subject to SOLAS regulations. The system is type approved only in the configuration specified in the certificate.

The type approval certificate is available at the product web site: www.navico.com/commercial.

System components

S3009 Control unit

The S3009 is a dedicated echosounder control unit with a 9-inch portrait display. The unit is fitted with a high brightness screen, suited for pilothouse installation.

Transducers

The system is certified with the following transducers:

- TGM50-200-xxL (200 kHz)
- TGM60-50-xxL (50 kHz)

S5100 Echosounder module

The S5100 is a networked echosounder module with 3 independent echosounder channels.

System examples

For system wiring examples refer to "*System examples*" on page 26.

2

The user interface

Front panel and keys

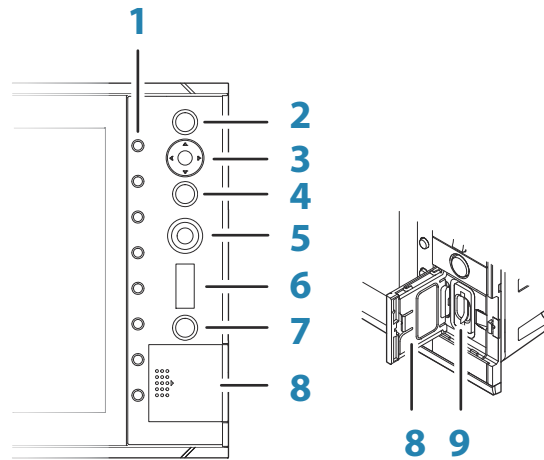

- 1 Softkeys**
Press a key once to access the corresponding function shown on the display.
- 2 ENT (Enter) key**
With no menu or no cursor active: no function.
Menu operation: press to select or deselect an option.
- 3 Arrow keys**
With no menu active: press to activate the cursor and to move the cursor on the image.
Menu operation: press to navigate through menu items and to adjust a value.
- 4 EXIT key**
With no menu or no cursor active: no function.
With cursor active: press to remove cursor.
Menu operation: press to return to previous menu level or to exit a dialog.
- 5 Rotary knob**
With no menu active: behavior depending on operational mode.
Menu operation: rotate to scroll through menu items and to adjust values. Press to select or to save settings.
On dual split panel: press to switch focus between the panels.
- 6 RANGE key**
Press the + or the - indication to increase or decrease the range.
- 7 Power key**
Press once to turn the system on.
When the system is running: press once to display the Brilliance pop-up.
Press and hold to display the Power off pop-up.
- 8 Card reader door**
- 9 SD card reader**

The main panel

The main panel is divided into predefined areas.

The panel can be set up as a single panel or as different split panels. Refer to *"Panel setup"* on page 18.

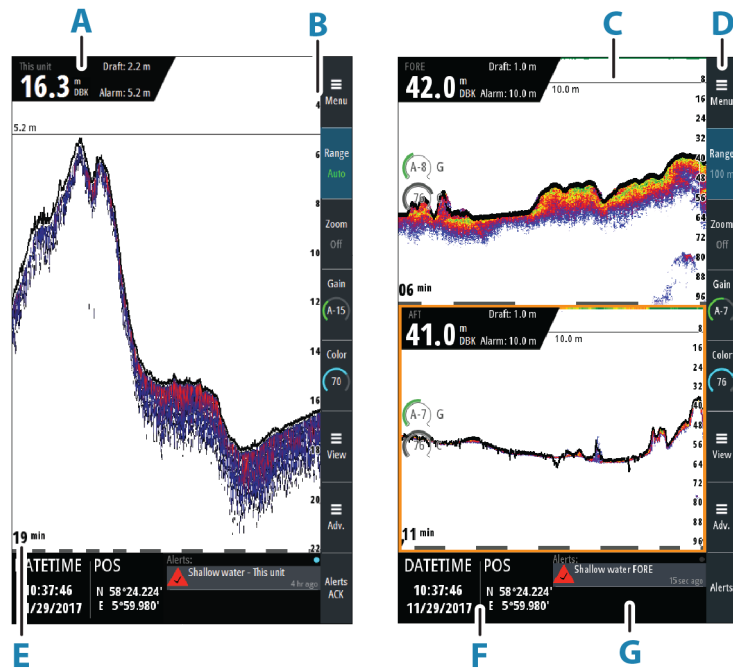

A Echosounder information panel

Current depth, source name, draft setting and alarm limit for active transducer

B Depth scale

Depth scale indication

C Depth alarm line

Visual indication of depth alarm setting

D Softkey bar

Indication of softkey function

E Data time scale

Time of depth history shown on the display

F Instrument bar

Two configurable data gauges

G Alerts panel

List of active alerts

Softkeys

When a softkey is pressed, the function for the selected softkey becomes available.

By default, the softkey bar is displayed on the panel. You can hide the softkey bar so that more of the image is displayed. Refer to *"Show or hide the softkey bar"* on page 19.

More details about the softkey functionality are available in the separate sections describing the functions later in this manual.

Softkey pop-ups

If you press the Range or Gain softkey twice, their corresponding pop-up is displayed.

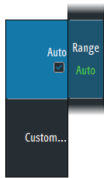

If a pop-up has more than one option, you select the options by using the arrow keys. You close the pop-up by re-pressing the softkey or by pressing the Exit key.

The menu system

The Menu, View and Advanced softkeys display menus.

- Use the up and down arrow keys or turn the rotary knob to move up and down in a menu
- Press the Enter key, the right arrow key or the rotary knob to access a sub menu, to toggle options or to confirm a selection
- Press the Exit key or the left arrow key to return to previous menu level and then exit the menu system

Main menu and sub menu

You access the Main menu by pressing the Menu softkey.

A selected menu item is indicated with a blue background. If a sub-menu is available, this is indicated with a right arrow after the text.

Some options display a slider. Turn the rotary knob or press the up/down arrow keys to adjust the value.

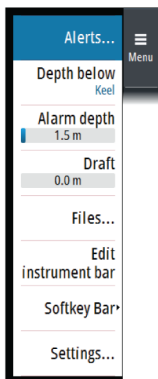

Settings dialogs

The various Settings dialogs provide access to system settings.

You access the Settings dialogs from the Main menu.

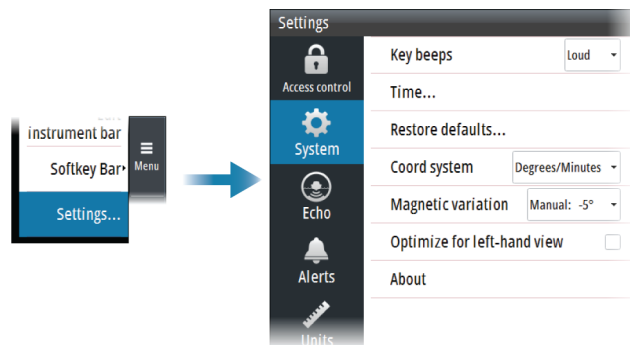

→ **Note:** Some of the parameters in the Settings dialogs are intended for system setup and service engineers. These parameters are protected, and they are only available by entering the password **QWERTY** in the Access control dialog.

There is no time-out for the Settings dialogs. A dialog remains open until it is manually closed.

For more information about the Settings dialogs, refer to *"Software setup"* on page 38.

On-screen keyboard

A numeric or alphanumeric virtual keyboard is displayed when required to enter user information in dialogs.

- Select a virtual key by using the arrow keys followed by the Enter key to confirm the selection
- Complete the entry and close the dialog by selecting the Enter virtual key

You remove the virtual keyboard without entering information by pressing the Exit key.

3

Basic operation

Turning the system on and off

The unit is turned on by pressing the Standby/Brilliance key. Press and hold the Standby/Brilliance key to turn the unit off.

Adjusting display brilliance

The brilliance is adjusted from the Brilliance pop-up.

- Display the pop-up by pressing the Standby/Brilliance key, then adjust the display brilliance by turning the rotary knob.

At first start-up, the display brilliance is set to 100%. When the unit is restarted, the brilliance is automatically set to the level it was prior to switching the unit off.

The system includes a Day and a Night color palette. When the brilliance is set to 40% or lower, the system switches to use the night palette.

- With the pop-up open, you switch between Day and Night palette by pressing the left (40%) or right (100%) arrow keys.

You close the pop-up by pressing the Exit key.

Acknowledging alerts

The Alerts softkey is labelled Alerts Acknowledge (Alerts Ack on smaller screens) if there is an unacknowledged alarm or warning in the system.

Acknowledge the most recent alert by pressing the Alerts softkey.

- Repeat pressing this softkey to continue to acknowledge alerts from the top of the Alerts panel.
- Press the Exit key to exit the Alerts panel.

When an alert is acknowledged, the alert icon stops flashing and changes to the acknowledged icon. The siren continues to sound if there are remaining unacknowledged alerts, otherwise it is muted.

The acknowledged alert is not moved to its new position in the sort order until there has been 2 seconds without any alerts being acknowledged.

For more details, refer to *"The alert system"* on page 22.

Adjusting depth settings

The depth reference

You can show the depth referenced to the surface, the keel or to the transducer.

The depth reference is indicated in the echosounder information panel (A) as either DBS (Depth Below Surface), DBK (Depth Below Keel) or as DBT (Depth Below Transducer).

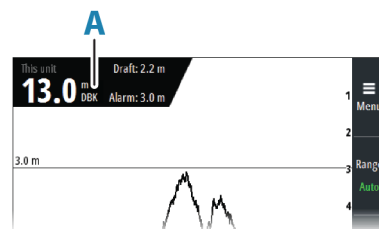
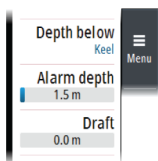
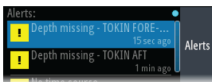
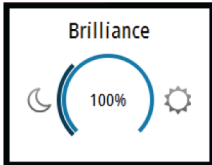

Alarm depth

An alarm is generated if the measured depth becomes shallower than the set alarm limit. The depth alarm limit is indicated in the echosounder information panel (A), and a horizontal line (B) indicates the depth settings on the image.

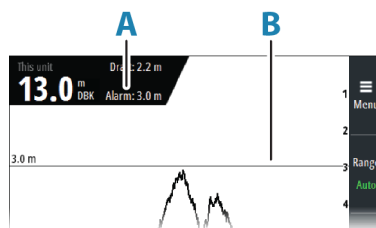

The alarm depth is always shown with the same reference as the measured depth.

Draft

The draft setting can be adjusted for different sailing and load conditions. The draft value is indicated in the echosounder information panel (A).

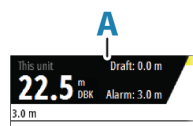

→ **Note:** If dual panels are used, the draft value can be set individually for each panel.

Zooming the image

You zoom the image by pressing the Zoom softkey and then turning the rotary knob. You can pan the zoomed area with the arrow keys.

The zoom level is shown in the Zoom softkey.

You can also zoom the image by using the Split Zoom option. Refer to "Split screen options" on page 18.



Using the cursor on the image

You activate the cursor by pressing any arrow key. Use the arrow keys to move the cursor on the image.

When the cursor is active, the depth at the cursor position is displayed (A), and the cursor information window (B) is activated. The two upper softkeys (C) change to show cursor relevant options.

To remove the cursor and cursor elements from the panel, press the Clear softkey or the Exit key.

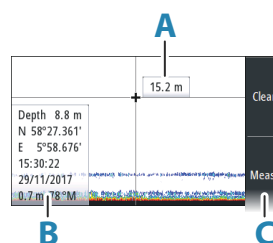

Measuring distance

The cursor can be used to measure the distance between the position of two observations on the image.

1. Position the cursor on the point from where you want to measure the distance
2. Start the measuring function by pressing the Meas. softkey
3. Position the cursor on the second measuring point
 - A line **(A)** is drawn between the measuring points, and the distance **(B)** listed in the Cursor Information window
4. Press the Enter key to switch reference point to cursor position
5. Continue selecting new measuring points if required

Press the Fin softkey to exit the measurement feature.

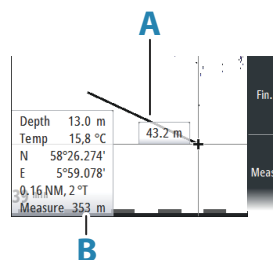

Viewing the depth history

Whenever the cursor is active, the history scroll bar is shown at the bottom of the image **(A)**. The history bar shows the image you are currently viewing in relation to the total depth history stored.

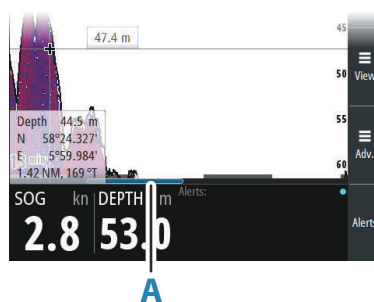

- Use the arrow keys to pan the image to show image history.

To resume normal scrolling, press the Clear softkey or the Exit key.

4

Setting up the echosounder image

Setting the range

The system includes a manual and an automatic range mode.

- In manual mode, the depth range can be set independent of the depth of the water. You can select a preset range level or define a custom range
- In auto mode, the system automatically displays the whole range from the water surface to the bottom

→ **Note:** Setting a deep manual range in shallow water may cause the system to lose track of the depth.

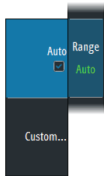

Preset range levels

Select a preset range level manually by:

- using the + and - icons on the Range key
- pressing the Range softkey once, and then turning the rotary knob

Auto range

In auto range, the system automatically displays the whole range from the water surface to the bottom.

Select Auto range by:

- pressing the Range softkey twice to display the pop-up, and then selecting the Auto option
- pressing and holding the Range softkey to toggle the Auto option on/off

Custom range

This option allows you to manually set both upper and lower range limits.

Set a custom range by:

- pressing the Range softkey twice to display the pop-up, and then selecting the Custom option.

→ **Note:** Setting a custom range puts the system in manual range mode.

Adjusting color and gain settings

Gain

The gain controls the sensitivity. The more you increase the gain, the more details are shown on the image. However, a higher gain setting may introduce more background clutter. If the gain is set too low, weak echoes might not be displayed.

A manual and an automatic gain mode are available. By default, the gain is set to Auto.

Adjust the gain manually by:

- pressing the Gain softkey once, and then turning the rotary knob

Auto gain

The Auto gain option keeps the sensitivity at a level that works well under most conditions. With the gain in auto mode, you can set a positive or negative offset that gets applied to the auto gain.

Select Auto gain by:

- pressing the Gain softkey twice to display the pop-up, and then selecting the Auto option
- pressing and holding the Gain softkey to toggle the Auto gain option on/off

In Auto mode, the gain offset can be manually fine-tuned by turning the rotary knob. The text within the control icon will then change from AUTO to A ± XX indicating that the auto setting is manually adjusted.

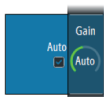



Color

Strong and weak signals have different colors to indicate the different signal strengths. The colors used depend on which palette you select. The more you increase the Color setting, the more echoes are displayed in the color at the strong return end of the scale.

To set the Color:

- press the Color softkey once, then turn the rotary knob to adjust the value.

Display time

You can change the length of the depth history shown on the display. This does not affect already collected data, so the length of depth history shown will gradually change from the old to the new value when changing display time.

The numeric value (**A**) in the lower-left corner of the panel always shows the age of the leftmost column on the screen.

A zebra scale (**B**) is shown at the bottom of the image, and each stripe equals one minute.

If there is a discontinuity in the depth signal, this is indicated with a triangle (**C**).

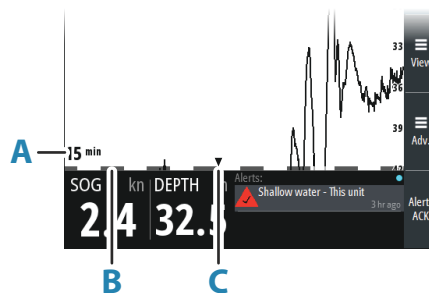
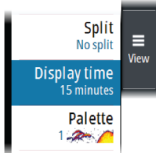

Optional image items

Palettes

You can select between several display palettes.

White marker

Use this option to change a specific color on the image to white. This effectively highlights (or hides) the selected color.

Bottom line

The bottom line option makes it easier to distinguish the bottom from other objects. You can specify the thickness of the line.

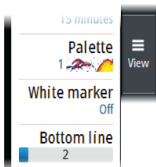

Advanced options

Frequency

The unit supports several transducer frequencies. Available frequencies depend on the transducer model that is configured for use.

Noise rejection

Signal interference from bilge pumps, engine vibration and air bubbles can clutter the image.

The noise rejection option filters the signal interference and reduces the on-screen clutter.

TVG

Wave action and boat wakes can cause onscreen clutter near the surface. The TVG (Time Variable Gain) option reduces surface clutter by decreasing the sensitivity of the receiver near the surface.

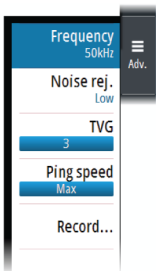

Ping speed

Ping speed controls the rate the transducer transmits the signal into the water. By default, the ping speed is set to max. It may be necessary to adjust the ping speed to limit interference.

5

Panel setup

Selecting transducer source

Depth data can be obtained from more than one transducer connected to the system. Refer to "System examples" on page 26.

Select the transducer to be shown in a panel from the View menu.

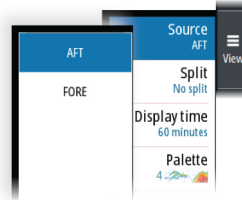

Split screen options

Dual

The dual split option allows for viewing signals from two transducers at the same time.

When the function is selected, use the orientation option (A) to select if the panels shall be arranged on top of each other or side-by-side.

Gain and color icons (B) are displayed on dual panels.

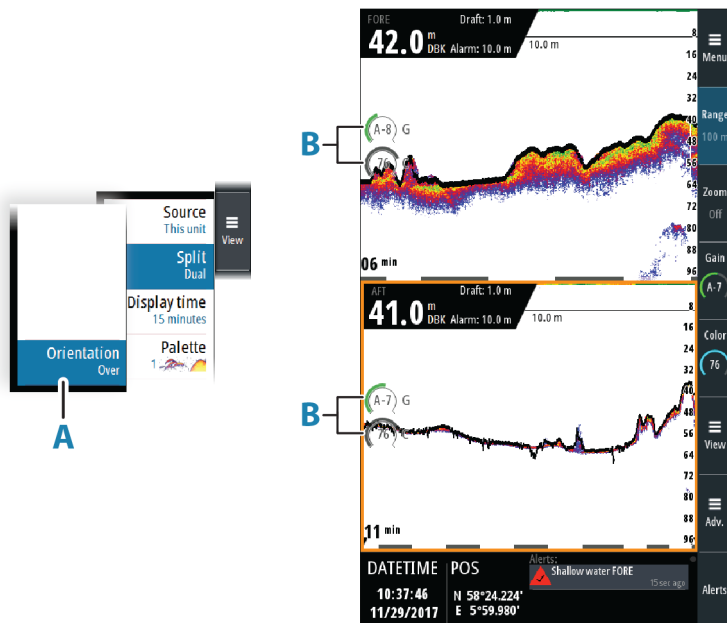

Press the rotary knob to switch focus between the panels. Active panel is indicated with a border.

Zoom

The split Zoom mode presents a magnified view of the sounder image on the left side of the panel.

By default, the zoom level is set to 2x, and you can increase this up to 8x.

Change the zoom level by pressing the Zoom softkey and then turning the rotary knob.

Zoom bars (A) are available from the View menu. The bars indicate the range that is magnified and displayed on the left side.

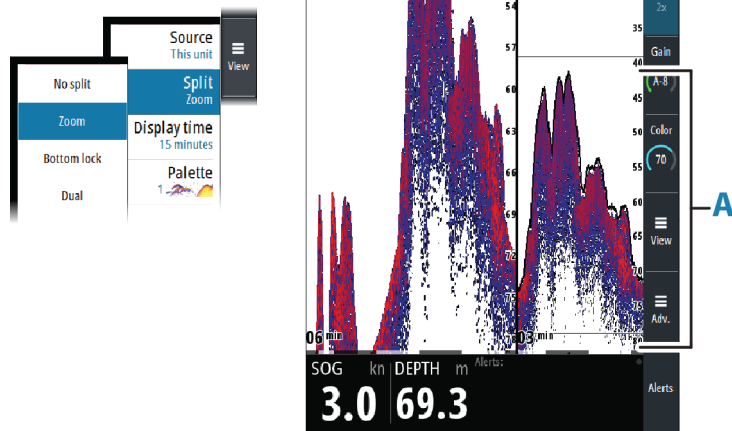

Bottom lock

The bottom lock mode is useful when you want to view echoes close to the bottom. In this mode, the left side of the panel shows an image where the bottom is flattened. The range scale is changed to measure from the seabed (0) and upwards. The bottom and the zero line are always shown on the left image, independent of the range scale. The scaling factor for the image on the left side of the panel is adjusted as described for the Zoom option.

Show or hide the softkey bar

By default, the softkey bar is displayed on the panel.

Select the hide menu option to immediately hide the softkey bar. Pressing any softkey re-displays the softkey bar.

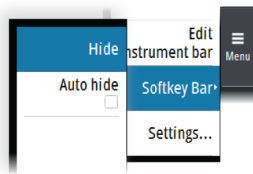

Auto hide the softkey bar

Selecting the auto hide option will hide the softkey bar after a few seconds of no softkey activity. Pressing any softkey re-displays the softkey bar.

Edit the content of the Instrument bar

The data types shown in the instrument bar gauges can be changed.

To select a gauge for editing:

- Select the Edit instrument bar in the main menu, then use the arrow keys to select the gauge
 - Active gauge is indicated with a border
- Press the Enter key to select preferred data
- Select the finish editing option in the menu to confirm the changes and leave edit mode

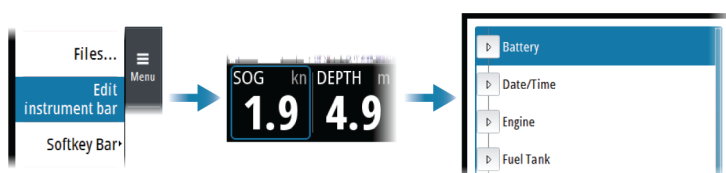

6

Advanced options

Recording depth data

You can record depth data. The file can be saved internally in the unit or onto a card inserted into the unit's card reader.

When the data is being recorded, a message appears periodically at the bottom of the screen.

You specify the log details in the log dialog.

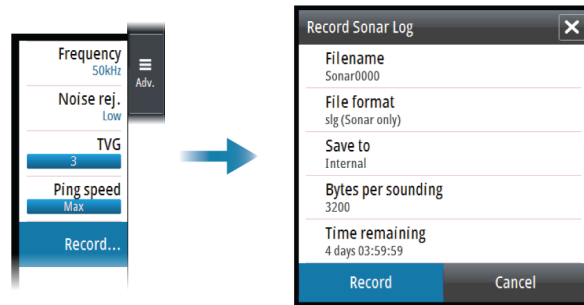

Managing files

Select the files option in the Main menu to open the Files dialog.

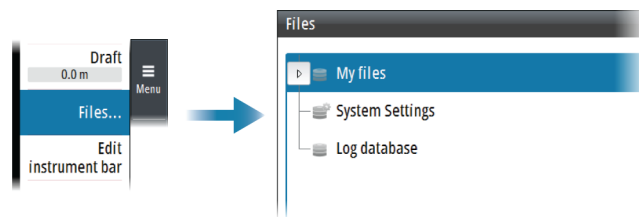

You can copy, rename, and delete files. You can transfer files from the unit to a memory card in the card reader and vice-versa using the copy option.

Simulator

The simulation feature lets you see how the unit works without being connected to sensors or other devices.

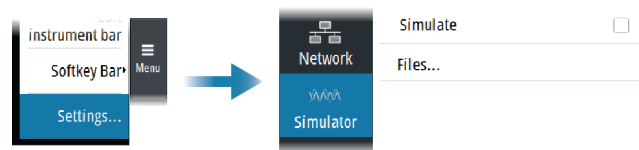

Simulator source files

You can select which data files that are used by the simulator. It can be either pre-recorded data files included in your device, your own recorded log files, or files on a card inserted in the unit's card reader.

7

Data logging

Depth data, alerts history and NMEA 0183 data are automatically saved to internal log files. The files can be exported using the Files option. Refer to *"Exporting the log files"* on page 21.

Depth log

Every second the depth data from all shown transducers is stored, along with the ship's position and time. Data is split in individual files for periods of 12 hours.

Logs from the last 72 hours are stored in the internal memory.

If an SD card is inserted, logs will also be automatically written to the card. There is no age limit on data stored on the SD card, and data will be recorded until the SD card is full. At this time, the oldest log file will be deleted.

Alert log

An alert log is stored internally. The log contains time, time source, alert ID, alert text, and alert action for the most recent 300 alert events.

NMEA 0183 data log

All serial output sentences sent over the NMEA 0183 connection are logged to an internal file. You can export and review this file for service and fault finding purposes.

The maximum file size is predefined. The system logs as much data as possible within the file size limitation, and then it starts overwriting the oldest data.

Exporting the log files

The log file can be exported from the Files dialog to a memory card in the card reader.

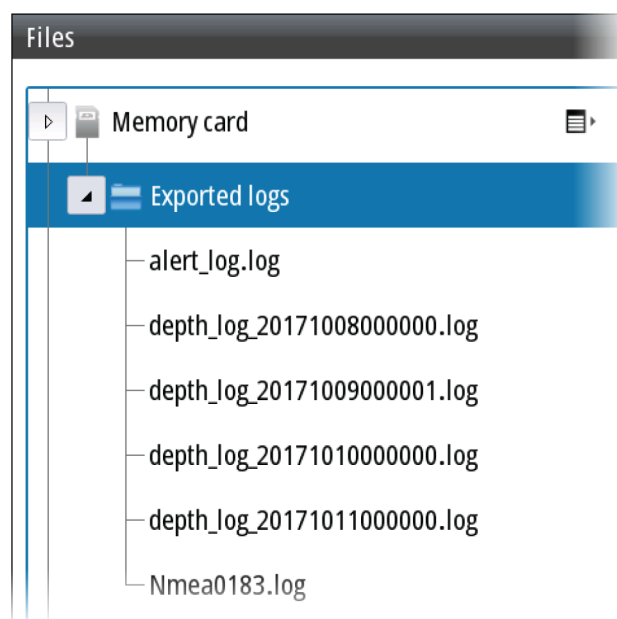
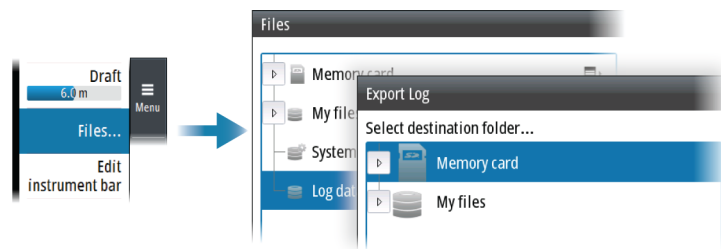

8

The alert system

The system will continuously check for danger situations and system faults while running.

Type of alerts

There are 2 alert types in the system:

- **Alarms:** This is the system's highest priority alert, activated when situation occurs that might result in collision, or for conditions that critically effect the capability or performance of the system. An alarm is accompanied by an audible signal, and the alarm icon flashes until the alarm is acknowledged.
- **Cautions:** This is information about danger and caution objects that require attention. Cautions have no audible signal.

Alert notifications

When an alert is triggered, the alert appears in the Alerts panel.

The alerts are displayed in a sorted order. The sort order is first by state (i.e. not acknowledged before rectified before acknowledged), then severity (i.e. alarm before caution), then age.





Alarms have different states:

- Active - not acknowledged, not silenced
- Active - acknowledged
- Rectified - not acknowledged

When an alert has been both rectified and acknowledged, it will disappear from the Alerts panel.

Cautions cannot be acknowledged, and they disappear from the alert list when the condition is rectified.

The table below shows alert icon and behavior depending on alert state.

Alert type	Icon	State	Indication
Alarm		Active - not acknowledged	<ul style="list-style-type: none">• Flashing symbol and descriptive text• Audible signal
		Active - acknowledged	<ul style="list-style-type: none">• Steady symbol and descriptive text• No audible signal
		Rectified - not acknowledged	<ul style="list-style-type: none">• Flashing symbol and descriptive text• No audible signal
Caution		Active	<ul style="list-style-type: none">• Steady symbol and descriptive text• No audible signal

Audible alert signal

The audible alert signal is by default turned ON.

You can select to disable the audible signal when service mode is active, but the audible signal will be reactivated when service mode is deactivated.

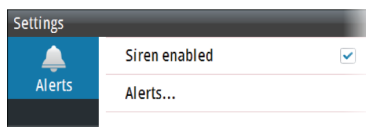

The Alerts dialog

The Alerts dialog is activated from the Alert settings or from the main menu.

The Alerts dialog includes a list of active alerts together with a historic listing of the last alert state changes. Entries are added to the history whenever an alert is raised, acknowledged, rectified or cleared.

All alerts in the Alerts dialog include a time stamp.

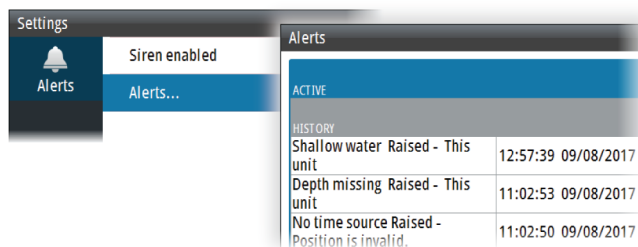

Alphabetic alert list

Alert type abbreviations:

- C: Caution
- A: Alarm

Alert text	Description	Type
BAM heartbeat lost	No HBT message is received. Only relevant if one or more NMEA 0183 ports are configured as BAM interface.	C
Depth missing	No depth data from selected sensor	C
Low voltage	Supply voltage <10 V (12V-15%)	C
No time source	No time data from NMEA 2000 or NMEA 0183 position sensor. Only relevant if the time setting is Auto.	C
Shallow water	Depth shallower then set limit	A

9

Mounting

S3009 Control unit

Mounting guidelines

→ **Note:** Where flush mounted, the enclosure should be dry and well ventilated. In small enclosures, it may be required to fit forced cooling.

⚠ Warning: Inadequate ventilation and subsequent overheating of the unit may cause unreliable operation and reduced service life. Exposing the unit to conditions that exceed the specifications could invalidate your warranty. – refer to "Technical specifications" on page 54.

Parts included

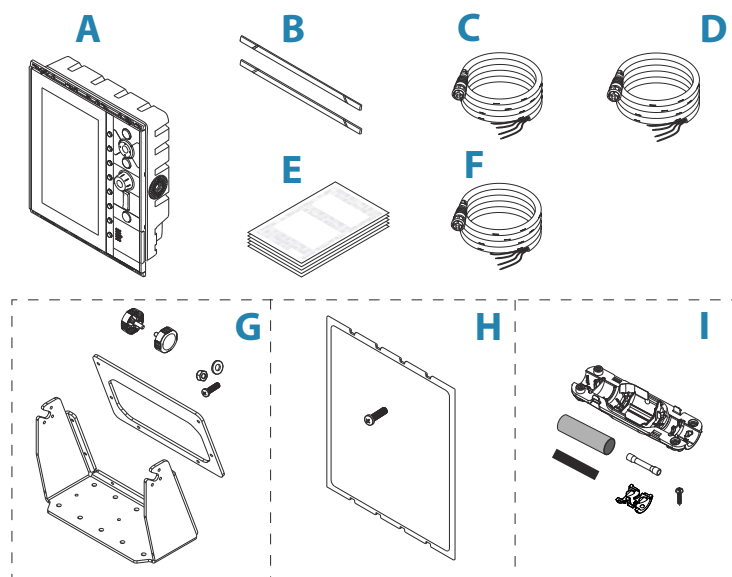

- A Control unit
- B Bezels
- C Transducer cable
- D Power cable
- E Document package
- F NMEA 0183 cable
- G U-bracket mounting kit
- H Panel mounting kit
- I Junction kit

U-bracket mounting

1. Place the bracket in the desired mounting location. Ensure that the chosen location has enough height to accommodate the unit fitted in the bracket, and allows tilting of the unit. In addition, adequate space is required on both sides to allow tightening and loosening of the knobs.
2. Mark the screw locations using the bracket as a template, and drill pilot holes. Use fasteners suited to the mounting surface material. If the material is too thin for self-tappers, reinforce it, or mount the bracket with machine screws and large washers. Use only 304 or 316 stainless steel fasteners.
3. Screw down the bracket.

4. Mount the unit to the bracket using the knobs. Hand tighten only. The ratchet teeth in the bracket and display case ensure a positive grip and prevent the unit changing from the desired angle.
5. Fix the bracket straps.

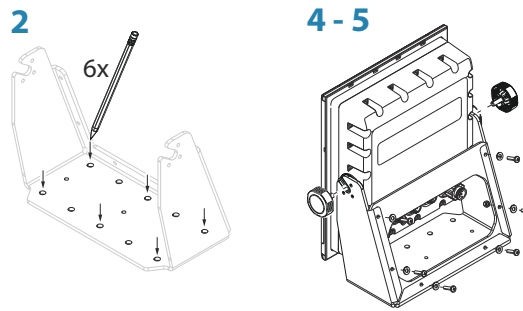

Panel mounting

The screws and gasket used for panel mounting are included in the box. For mounting instructions, refer to the mounting template.

Transducers

The ideal mounting location for transducers depend on the design of the vessel. The installation shipyard must ensure sufficient reinforcement and watertightness of the hull, and must design and manufacture installation hardware that fits the transducer and the vessel.

For dimensional drawings refer to "*Dimensions - TGM60-50-xxL and TGM50-200-xxL transducers*" on page 50.

S5100 echosounder module

For S5100 echosounder module mounting information, refer to separate installation instructions included with the module.

10

Wiring

Guidelines

Don't:

- make sharp cable bends
- run cables in a way that allows water to flow down into the connectors
- run the data cables adjacent to radar, transmitter, or large/high current carrying cables or high frequency signal cables
- run cables so they interfere with mechanical systems
- run cables over sharp edges or burrs

Do this:

- make drip and service loops
- use cable-tie on all cables to keep them secure
- solder/crimp and insulate all wiring connections if extending or shortening the cables. Extending cables should be done with suitable crimp connectors or solder and heat shrink. Protect joints from water, humidity and otherwise corrosive environments
- leave enough space for connecting and disconnecting cables

⚠ Warning: Before starting the installation, be sure to turn electrical power off. If power is left on or turned on during the installation, fire, electrical shock, or other serious injury may occur. Be sure that the voltage of the power supply is compatible with the unit.

⚠ Warning: The positive supply wire (red) should always be connected to (+) DC with a fuse or a circuit breaker.

System examples

Single transducer system

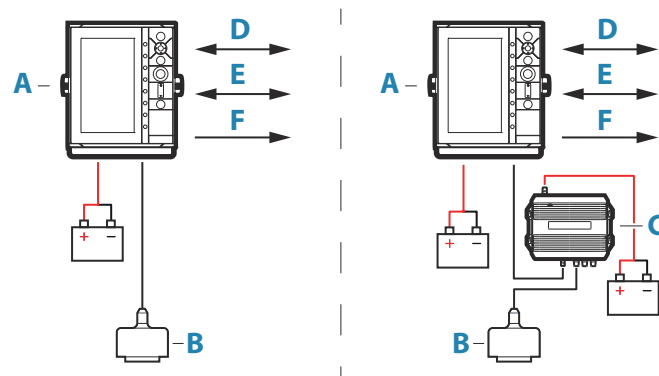

- A** S3009 control unit
- B** TGM50-200-xxL or TGM60-50-xxL transducer
- C** S5100 sonar module
- D** NMEA 0183/IEC61162-1
- E** NMEA 2000/IEC61162-3
- F** NC isolated alarm circuit

Dual transducer system

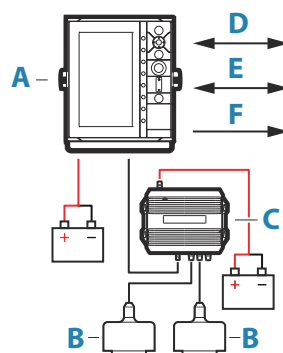

- A** S3009 control unit
- B** TGM50-200-xxL or TGM60-50-xxL transducer
- C** S5100 sonar module
- D** NMEA 0183/IEC61162-1
- E** NMEA 2000/IEC61162-3
- F** NC isolated alarm circuit

Transducer wiring

The transducers are shipped with a 20 meter long cable. An extension cable can be installed if a total length of more than 20 meters is required between the transducer and the S3009 or S5100 module.

For dual transducer installations, an S5100 module has to be installed.

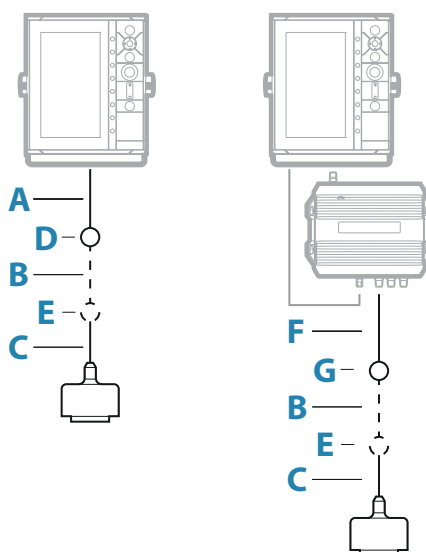

- A** S3009 7-pin transducer cable
- B** Optional extension cable
- C** Transducer cable (20 meters)
- D** Junction, 7-pin transducer cable (A) to transducer cable (C) or optional extension cable (B)
- E** Junction (optional), extension cable (B) to transducer cable (C)
- F** S5100 9-pin transducer cable
- G** Junction, 9-pin transducer cable (F) to transducer cable (C) or optional extension cable (B)

Extension cable

An extension cable can be installed if a total length of more than 20 meters is required between the transducer and the S3009 or S5100 module.

→ **Note:** A 2 x 2,5/2,5 mm² or a 2 x 1,5/1,5 mm² cable shall be used.

S3009 transducer wiring

The S3009 is equipped with a 7-pin transducer connector at the back of the unit.

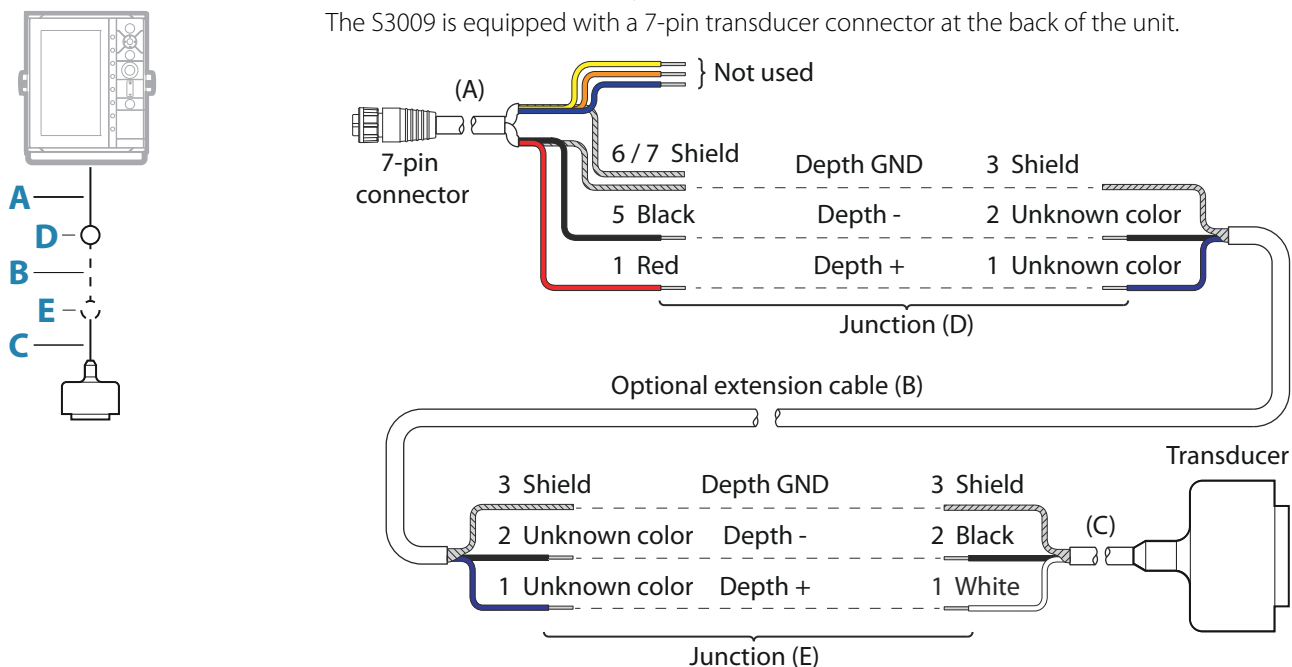

→ **Note:** For more details, refer to "Extension cable" on page 28 and "Junction details" on page 30.

Echosounder 7-pin connector details

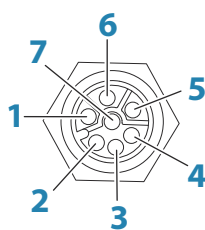

Unit socket (female)

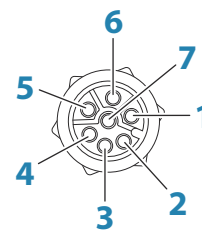

Cable plug (male)

Pin	Purpose
1	Depth +
2	Speed signal
3	Speed volts
4	Temp +
5	Depth -
6	Depth Gnd (shield)
7	Temp - (shield)

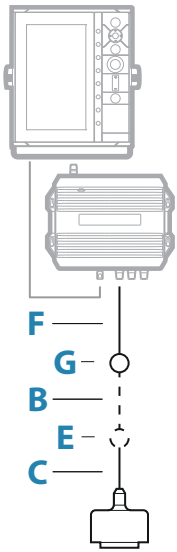

S5100 transducer wiring

The S5100 is equipped with three 9-pin transducer connectors.

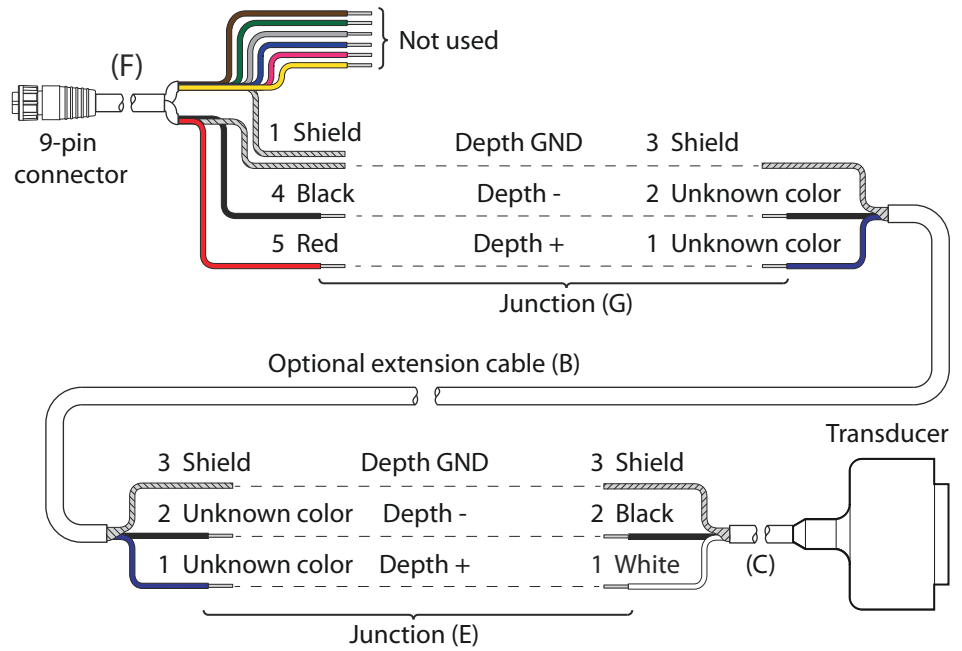

→ **Note:** For more details, refer to "Extension cable" on page 28 and "Junction details" on page 30.

Echosounder 9-pin connector details

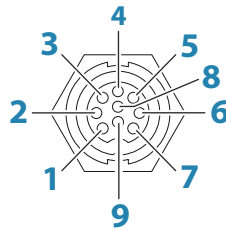

Unit socket (female)

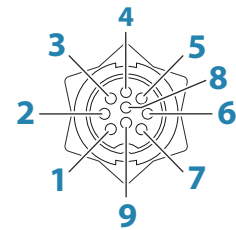

Cable plug (male)

Pin	Purpose
1	Drain/Ground
2	Starboard +
3	Starboard -
4	Transducer TX/RX -
5	Transducer TX/RX +
6	Port +
7	Port -
8	Temp
9	Transducer ID

Junction details

Junction E - 2 wire to 2 wire junction

→ **Note:** The terminal block supplied with the junction box shall not be used.

Dimensions:

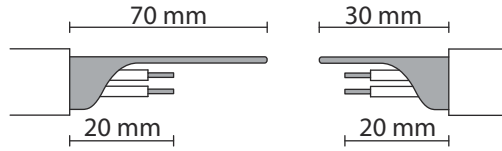

Step by step instructions:

	<ul style="list-style-type: none"> Slide the provided braided shield sleeve over one of the cables
	<ul style="list-style-type: none"> Remove the outer insulation of the cable according to dimensions Push back the cable's braided shield Remove insulation from the conductors
	<ul style="list-style-type: none"> Connect the conductors with crimp joiners using a professional crimp tool Seal the joint with self-vulcanizing tape
	<ul style="list-style-type: none"> Pull the braided shields over the joint
	<ul style="list-style-type: none"> Pull the provided braided shield sleeve over the joint Seal the joint with self-vulcanizing tape
	<ul style="list-style-type: none"> The joint is now ready to be sealed in the junction box. Refer to "<i>Junction box assembly</i>" on page 32

Junction D and G - multicore to 2 wire junction

→ **Note:** The terminal block supplied with the junction box shall not be used.

Dimensions:

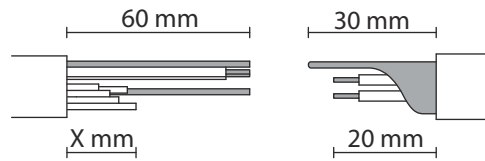

Cut the unused wires in the multicore cable in different lengths to avoid short-circuiting wires.

Step by step instructions:

	<ul style="list-style-type: none"> Slide the provided braided shield sleeve over one of the cables
	<ul style="list-style-type: none"> Remove the outer insulation of the 2-wire cable Push back the cable's braided shield Remove insulation from the conductors
	<ul style="list-style-type: none"> Remove the outer insulation of the multicore cable Remove the aluminum foil that surrounds the wires Separate the wires to be used from the other wires Remove insulation from the conductors to be used
	<ul style="list-style-type: none"> Connect the conductors to be used with crimp joiners using a professional crimp tool Seal the joints with self-vulcanizing tape
	<ul style="list-style-type: none"> Separate the shield wires from the other wires in the multicore cable Cut the unused wires in the multicore cable in different lengths to avoid short-circuiting wires Apply self-vulcanizing tape over the cut cables and the joint
	<ul style="list-style-type: none"> Pull the braided shield and shield wires over the joint
	<ul style="list-style-type: none"> Pull the provided braided shield sleeve over the joint Seal the joint with self-vulcanizing tape

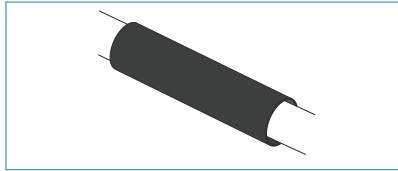

- The joint is now ready to be sealed in the junction box. Refer to "Junction box assembly" on page 32

Junction box assembly

→ **Note:** The terminal block supplied with the junction box shall not be used.

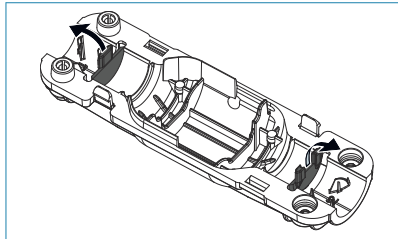

- Remove the plastic stoppers

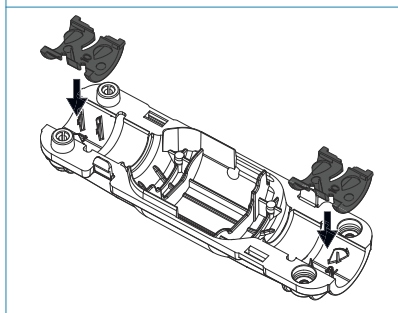

- Insert the spacers if the cable diameter is less than 9.5 mm
- Use an optional junction box (sold separately) if the cable diameter exceeds 12.0 mm

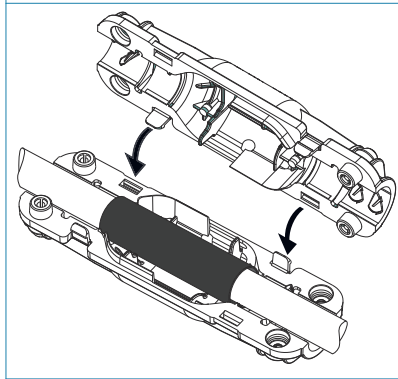

- Place the cable and joint centered in the junction box
- Attach the junction box lid

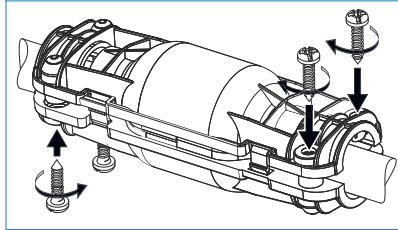

- Secure the junction box lid with the supplied screws

Power wiring

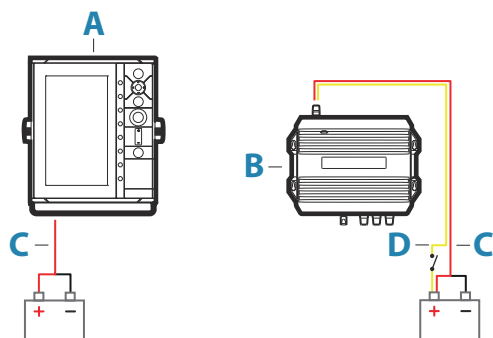

- A** S3009 control unit
- B** S5100 Echosounder module
- C** Power cable
- D** Power control wire

S3009 power wiring

Power connector details

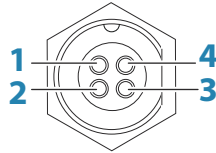

Unit socket (male)

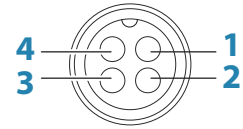

Cable plug (female)

Pin	Purpose	Color
1	DC negative	Black
2	External alarm output (N/C isolated contact)	Blue
3	External alarm output negative return	Yellow
4	+12/24 V DC	Red

Power connection

The unit is designed to be powered by a 12 or 24 V DC system.

It is protected against reverse polarity, under voltage, and over voltage (for a limited duration).

A fuse or circuit breaker should be fitted to the positive supply. For recommended fuse rating, refer to the technical specification in the "Appendix" on page 47.

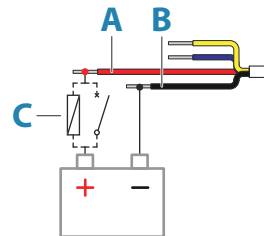

Key	Purpose	Color
A	+12/24 V DC	Red
B	DC negative	Black
C	Fuse or circuit breaker	

S5100 echosounder module power wiring

For S5100 echosounder module grounding and power connection, refer to separate wiring instructions included with the module.

→ **Note:** For transducer connection refer to "Transducer wiring" on page 27. Separate documentation included with the S5100 echosounder module shall not be used for transducer wiring.

Ethernet wiring

Both the S3009 and S5100 are equipped with a 5-pin Ethernet connector and can be connected with a 5-pin Ethernet cable.

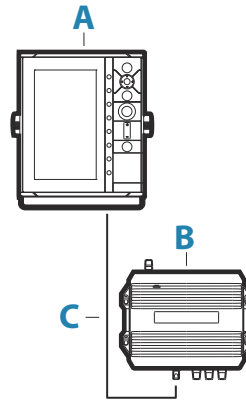

- A S3009 control unit
- B S5100 echosounder module
- C 5-pin Ethernet cable

Ethernet connector details

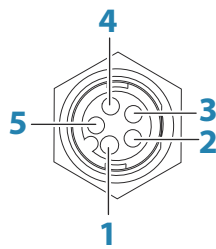

Unit socket (female)

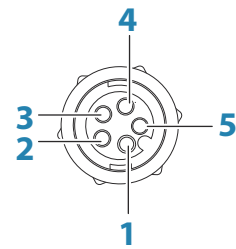

Cable plug (male)

Pin	Purpose
1	Transmit positive TX+
2	Transmit negative TX-
3	Receive positive RX+
4	Receive negative RX-
5	Shield

NMEA 0183 wiring

The NMEA 0183 serial port provides input (Listeners) and outputs (Talkers) for the various IEC 61162 interfaced sensors. The port uses the NMEA 0183 (serial balanced) standard, and can be configured in the software for different baud rates up to 38,400 baud. For configuring of the ports, refer to "Serial ports" on page 43.

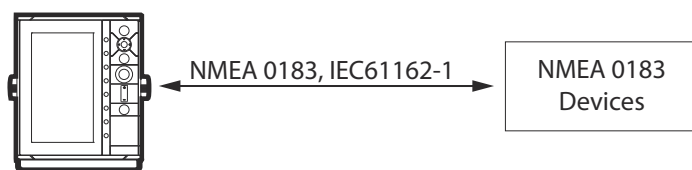

NMEA 0183 connector details

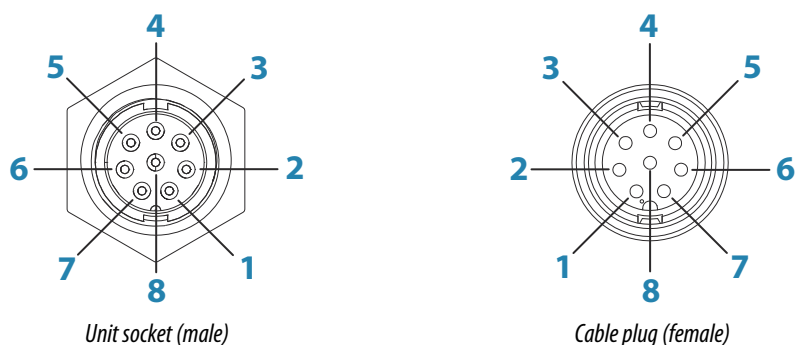

Pin	Port	Purpose
1	Port 2	Listener B (Rx+)
2	Port 2	Listener A (Rx-)
3	Port 2	Talker B (Tx+)
4	Port 2	Talker A (Tx-)
5	Port 1	Talker B (Tx+)
6	Port 1	Talker A (Tx-)
7	Port 1	Listener A (Rx-)
8	Port 1	Listener B (Rx+)

NMEA 0183 cable details

For wire color coding of the supplied NMEA 0183 cable(s) see table below.

Pin	Color
1	Brown/White
2	Brown
3	Green/White
4	Green
5	Orange/White
6	Orange
7	Blue/White
8	Blue

Talkers and Listeners

Do not connect multiple devices outputting data (Talkers) on to any serial input (RX) of the unit. The RS422 protocol is not intended for this type of connection, and data will be corrupted if more than one device transmits simultaneously. The output (TX) however may drive multiple receivers (Listeners). The number of receivers is finite, and depends on the receiving hardware. Typically three devices is possible.

NMEA 2000 wiring

The NMEA 2000 data port allows the receiving and sharing of a multitude of data from various sources.

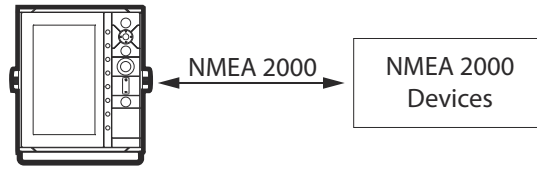

NMEA 2000 connector details

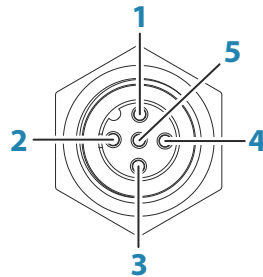

Unit socket (male)

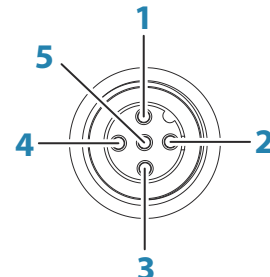

Cable plug (female)

Pin	Purpose
1	Shield
2	NET-S (+12 V DC)
3	NET-C (DC negative)
4	NET-H
5	NET-L

External alarm wiring

The external alarm is connected through the power connector.

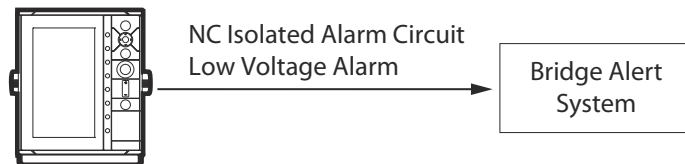

Power connector details

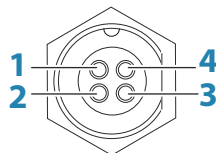

Unit socket (male)

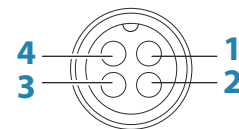

Cable plug (female)

Pin	Purpose	Color
1	DC negative	Black
2	External alarm output (N/C isolated contact)	Blue
3	External alarm output negative return	Yellow
4	+12/24 V DC	Red

External alarm

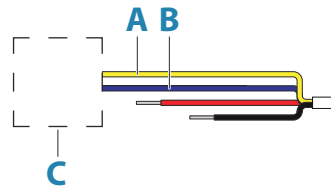

Key	Purpose	Color
A	External alarm output negative return	Yellow
B	External alarm output (N/C isolated contact)	Blue
C	Alert management system	

11

Software setup

Software setup sequence

1 S5100 software update

To use the S5100 in an IMO compliant system, the S5100 must have a dedicated software version. The update file is found in the S5100 Updaters folder on the S3009 unit.

Refer to *"Software upgrades"* on page 45 and *"Managing files"* on page 20.

2 Time

Set the time, date and format in the Time settings dialog. If an external time source is connected to the device, set Time setting to Auto to automatically update the current time. Refer to *"System settings"* on page 38.

3 Source selection

Make sure that the proper external data sources have been selected. Refer to *"Network settings"* on page 41.

4 Echosounder settings

Configure the transducer(s) from the Echo Installation dialog. Source name, keel offset and transducer type should be configured for all connected transducers. Refer to *"Echo settings"* on page 39.

Accessing the settings dialog

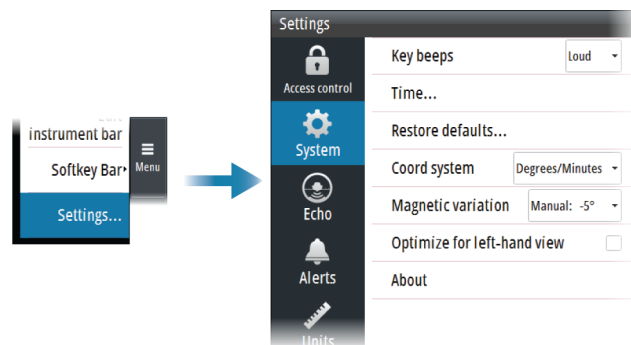

Access control

Some of the parameters in the Settings dialogs are intended for system setup and service engineers. These parameters are password protected, and they are only available by entering the un-lock code in the Access control dialog.

The access control password is: **QWERTY**.

Service mode must be selected to get access to all settings.

Service mode does not time out, but it is deactivated when you close the Settings dialogs.

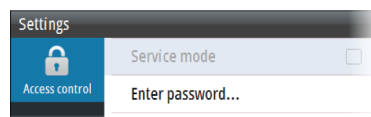

System settings

Use the system settings dialog to set basic settings as described below. Some settings require a reboot of the system.

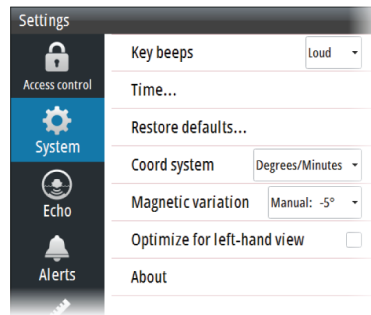

Key beeps

Controls the loudness of the beep sound when a key is pressed.

Time

Controls the local time zone offset, and the format of the time and date.

Restore defaults

Restore settings to default factory settings.

Coordinate system

Several coordinate systems can be used to control the format for latitude and longitude coordinates.

Magnetic variation

Defines how magnetic variation is handled by the system.

- Auto: Receives variation data from a network source
- Manual: Used for manually entering a value for the magnetic variation

Optimize for left-hand view

Select this option to optimize the display for viewing from the left.

About

Displays copyright information, software version, and technical information for this unit.

Echo settings

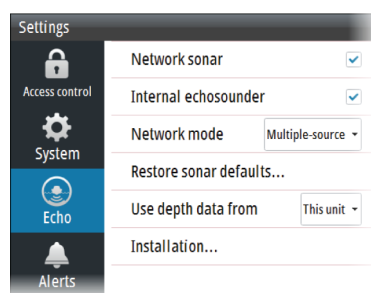

Network Echosounder

Select to share transducers from this unit with other units connected on the Ethernet network. In addition, the setting must be selected in order to see other enabled sonar devices on the network.

When unselected, transducers connected to this unit cannot be shared with other units connected on the network, nor can it see other sources on the network that have this feature enabled.

Internal echosounder

When selected, the internal echosounder is available for selection in the echosounder panel menu.

When unselected, this option disables the internal echosounder in the unit. It will not be listed as an echosounder source for any unit on the network. Unselect this option on units which do not have a transducer connected.

Network echosounder mode

The network echosounder mode setting selects whether only one or multiple echosounder sources can be selected at the same time.

→ **Note:** Changing the mode requires that all connected sources are restarted.

Restore sonar defaults

Restore echosounder settings to default.

Use depth data from

Select which depth source that shares data on the NMEA 2000 network and on the NMEA 0183 (DPT sentence).

Installation

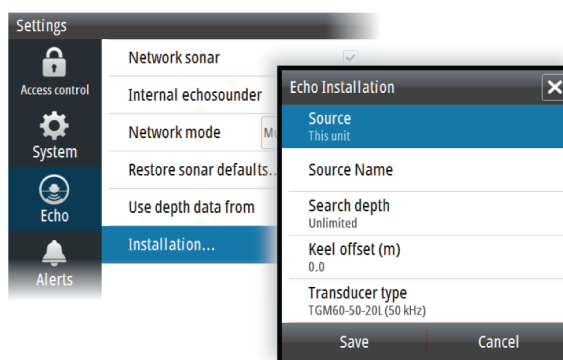

Source

Select this option to display a list of Echosounder sources available for setup. The settings you make in the rest of the dialog pertain to the source selected.

Source name

Select this option to set a descriptive name for the selected transducer.

Search depth

Noise may cause the echosounder to search for unrealistic depths. By setting the search depth manually the system displays echoes received from objects within the set depth range.

Keel offset

All transducers measure water depth from the transducer to the bottom. As a result, water depth readings do not account for the distance from the transducer to the lowest point of the boat (for example; bottom of the keel, rudder or propeller) in the water or from the transducer to the water surface.

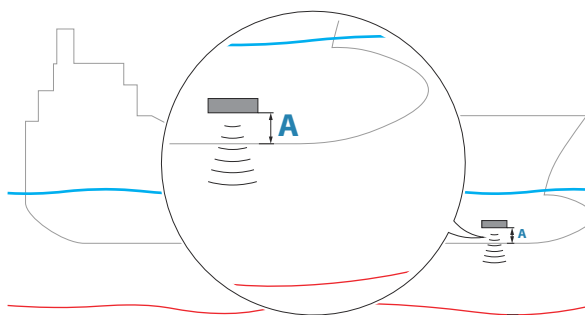

A Keel offset

Set the keel offset to the distance from the bottom of the transducer to the lowest point of the boat in the water (positive value).

Transducer type

Transducer type is used for selecting the transducer model connected to the sonar module. The transducer selected will determine what frequencies the user can select during operation.

Units settings

Used for specifying the units of measurement displayed.

Network settings

Use the Network settings dialog to setup networks and connect to network devices.

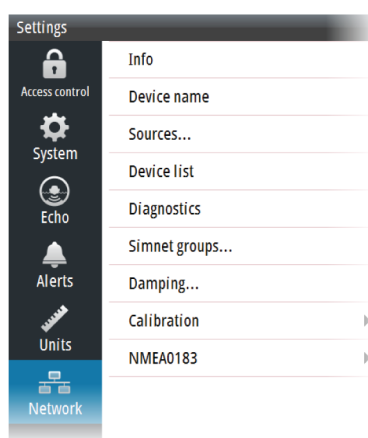

Info

Displays the Ethernet connection status, the unit's IP and MAC addresses.

Device name

Assigning a name is useful in systems using more than one device of the same type and size.

Data source selection

→ **Note:** If NMEA 0183 is used, complete the NMEA 0183 setup prior to doing source selection. Refer to "*NMEA 0183 setup*" on page 43.

Data sources provide live data to the system.

The data may originate from modules internal to the unit, or external modules connected to the NMEA 2000 or via NMEA 0183 if available on the unit.

When a device is connected to more than one source providing the same data, the user can choose the preferred source. Before commencing with source selection make sure all external devices and the NMEA 2000 backbone are connected and are turned on.

Auto select data sources

The Auto select option looks for all sources connected to the unit. If more than one source is available for each data type, selection is made from an internal priority list. This option is suitable for the majority of installations.

→ **Note:** Auto data source selection may already have been selected at first time startup. However, it should be redone if any new devices have been added to the network since.

Advanced data source selection

The advanced option allows for you to manually select or unselect data sources. Manual selection is generally only required where there is more than one source for the same data, and the 'Auto select' selected source is not the one desired.

Device list

The Device list shows all NMEA 2000 devices.

Selecting a device in this list will bring up additional details and options for the device.

All devices allow allocation of an instance number in the Configure option. Set unique instance numbers on any identical devices on the network to allow the unit to distinguish between them. The Data option shows all data being output by the device. Some devices will show additional options specific to the device.

→ **Note:** Setting the instance number on a 3rd party product is typically not possible.

Diagnostics

The NMEA 2000 tab on the diagnostics page can provide information useful for identifying an issue with the network.

→ **Note:** The following information may not always indicate an issue that can be simply resolved with minor adjustment to network layout or connected devices and their activity on the network. However, Rx and Tx errors are most likely indicating issues with the physical network, which may be resolved by correcting termination, reducing backbone or drop lengths, or reducing the number of network nodes (devices).

Bus state

Indicates whether the bus is powered, but not necessarily connected to any data sources. However, if bus shows as off, but power is present along with an increasing error count, it is possible that termination or cable topology is incorrect.

Rx Overflows

The unit received too many messages for its buffer before the application could read them.

Rx Overruns

The unit contained too many messages for its buffer before the driver could read them.

Rx/Tx Errors

These two numbers increase when there are error messages, and decrease when messages are received successfully. These (unlike the other values) are not a cumulative count. Under normal operation these should be at 0. Values around 96 upwards indicate a heavily error prone network. If these numbers go too high for a given device, it will automatically drop off the bus.

Rx/Tx Messages

Shows actual traffic in and out of device.

Bus Load

A high value here indicates network is near full capacity. Some devices automatically adjust rate of transmission, if network traffic is heavy.

Fast Packet Errors

Cumulative counter of any fast packet error. This could be a missed frame, or a frame out of sequence etc. NMEA 2000 PGNs are made of up to 32 frames. The entire message will be discarded when a frame is missed.

→ **Note:** Rx and Tx Errors often indicate an issue with the physical network, which may be resolved by correcting termination, reducing backbone or drop lengths, or reducing the number of network nodes (devices).

Reset counters

Resets all counters in the NMEA 2000 tab of the Diagnostics dialog to zero. The counters start recounting immediately.

SimNet Groups

The SimNet Group function is used to control parameter settings, either globally or in groups of units. The function is used on larger vessels where several SimNet units are connected to the network. By assigning several units to the same group, a parameter update on one unit will have the same effect on the rest of the group members.

Damping

If data appears erratic or too sensitive, damping may be applied to make the information appear more stable. With damping set to off, the data is presented in raw form with no damping applied.

Calibration

An offset (positive or negative) can be applied to correct inaccuracies in boat speed, sea temp, air temp, barometric pressure, and depth sourced from NMEA 2000 devices.

NMEA 0183 setup

The NMEA 0183 port must be set to suit the speed of connected devices, and can be configured to output only the sentences required by listening devices.

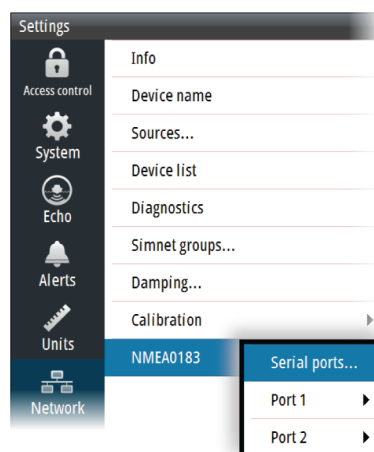

Serial ports

Specifies the baud rate for port for the devices connected to the NMEA 0183. The baud rate should be set to correspond with devices connected to the NMEA 0183 input and output.

Ports configuration

Each port can be configured to the following Modes:

- Disabled - select this mode if the port is not used (default mode)
- Standard - in this mode the output sentences can be manually configured
- BAM - select to communicate with an external Bridge Alert Management system conforming to IEC 61924-2
- Legacy alerts - select to communicate with a legacy BAM, using ALR and ACK sentences

12

Maintenance

Preventive maintenance

The unit does not contain any field serviceable components. Therefore, the operator is required to perform only a very limited amount of preventative maintenance.

If a sun cover is available, it is recommended that you always fit it when the unit is not in use.

Cleaning the display unit

A proper cleaning cloth should be used to clean the screen, where possible. Use plenty of water to dissolve and take away salt remains. Crystallized salt may scratch the coating if using a damp cloth. Apply minimal pressure to the screen.

Where marks on the screen cannot be removed by the cloth alone, use a 50/50 mixture of warm water and isopropyl alcohol to clean the screen. Avoid any contact with solvents (acetone, mineral turpentine, etc.), or ammonia based cleaning products, as they may damage the anti-glare layer or plastic bezel.

To prevent UV damage to the plastic bezel, it is recommended that the sun cover be fitted when the unit is not in use for an extended period.

Cleaning the media port door

Clean the media port door regularly to avoid salt crystallization on the surface, causing water to leak into the card slot.

Checking the keys

Make sure that no keys are stuck in the down position. If one is stuck, wiggle the key to free it back to normal.

Checking the connectors

The connectors should be checked by visual inspection only.

Push the connector plugs into the connector. If the connector plugs are equipped with a lock, ensure that it is in the correct position.

Software upgrades

The latest software is available for download from our website: www.navico.com/commercial.

Start the update by selecting the update file from the Files menu option.

The example shows the sequence when updating the S5100 with the file included in the S3009 unit.

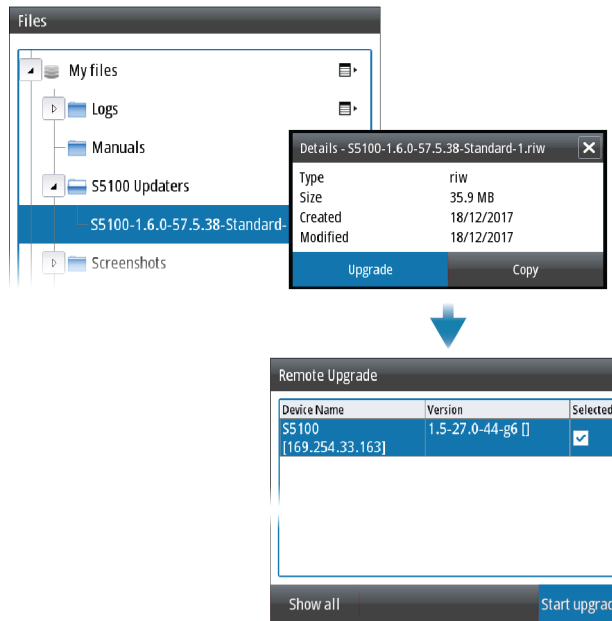

Before initiating an update to the unit itself, be sure to back up any potentially valuable user data.

Backing up your system data

It is recommended to regularly copy your system settings files as part of your back-up routine. The files can be copied to a card inserted in the card reader. Refer to *"Managing files"* on page 20.

13

Appendix

Menu overview

Softkey menus

The system includes a main Menu, a View menu and an Advanced menu as shown below. The menus are accessed by pressing the corresponding softkey.

Symbols used:

- > access sub menu
- ... open dialog

Softkey	Menu level 1	Menu level 2
Menu	Alerts ...	
	Depth below	
	Alarm depth	
	Draft	
	Files ...	
	Edit Instrument bar	
	Softkey bar >	Hide
		Auto hide
	Settings ...	
View	Source	
	Split	
	Display time	
	Palette	
	White marker	
	Bottom line	
	Zoom bars	
Advanced	Frequency	
	Noise rejection	
	TVG	
	Ping speed	
	Record ...	

Settings menu

The system includes a Settings menu, accessed from the main menu.

Level 1	Level 2	
Access control	Service mode	
	Enter password ...	
System	Key beeps	
	Time...	
	Restore defaults	
	Coordinate system	
	Magnetic variation	
	Optimize for left hand view	
	About	
Echo	Network sonar	
	Internal echosounder	
	Network mode	
	Restore sonar defaults ...	
	User depth data from	
	Installation ...	
Alerts	Siren enabled	
	Alerts ...	
Units	Distance	
	Distance small	
	Wind speed	
	Speed	
	Depth	
	Altitude	
	Heading	
	Temperature	
	Volume	
	Economy	
	Pressure	
	Baro pressure	
	Network	Info
		Device name
Sources ...		
Device list		
Diagnostics		
Simnet groups ...		
Damping ...		
Calibration >		
NMEA 0183 >		
Simulator	Simulate	
	Files ...	

Dimensional drawings

Dimensions - S3009 Control unit

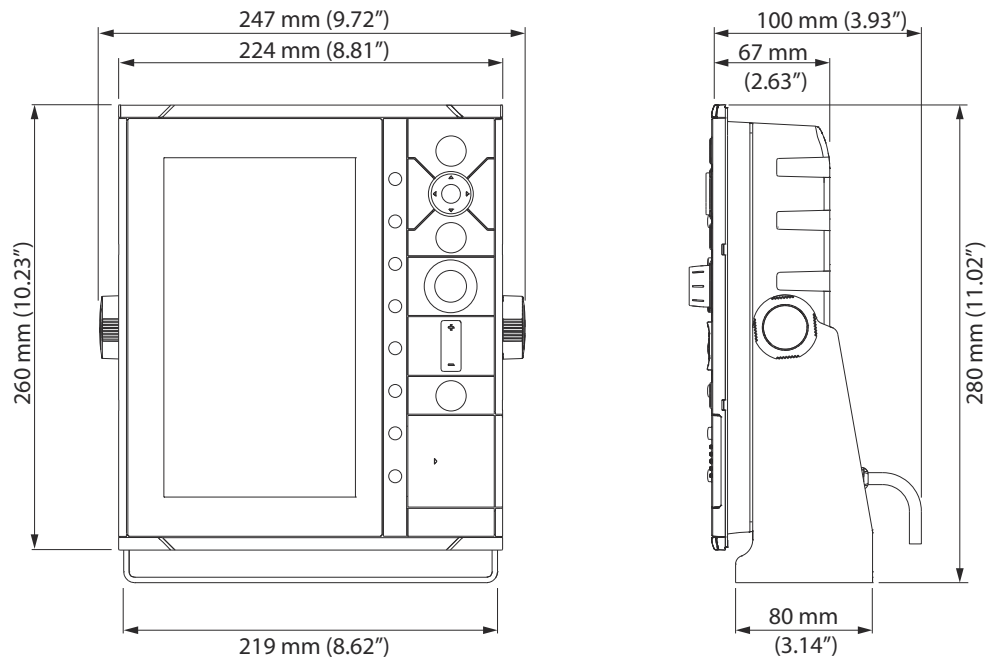

Dimensions - TGM60-50-xxL and TGM50-200-xxL transducers

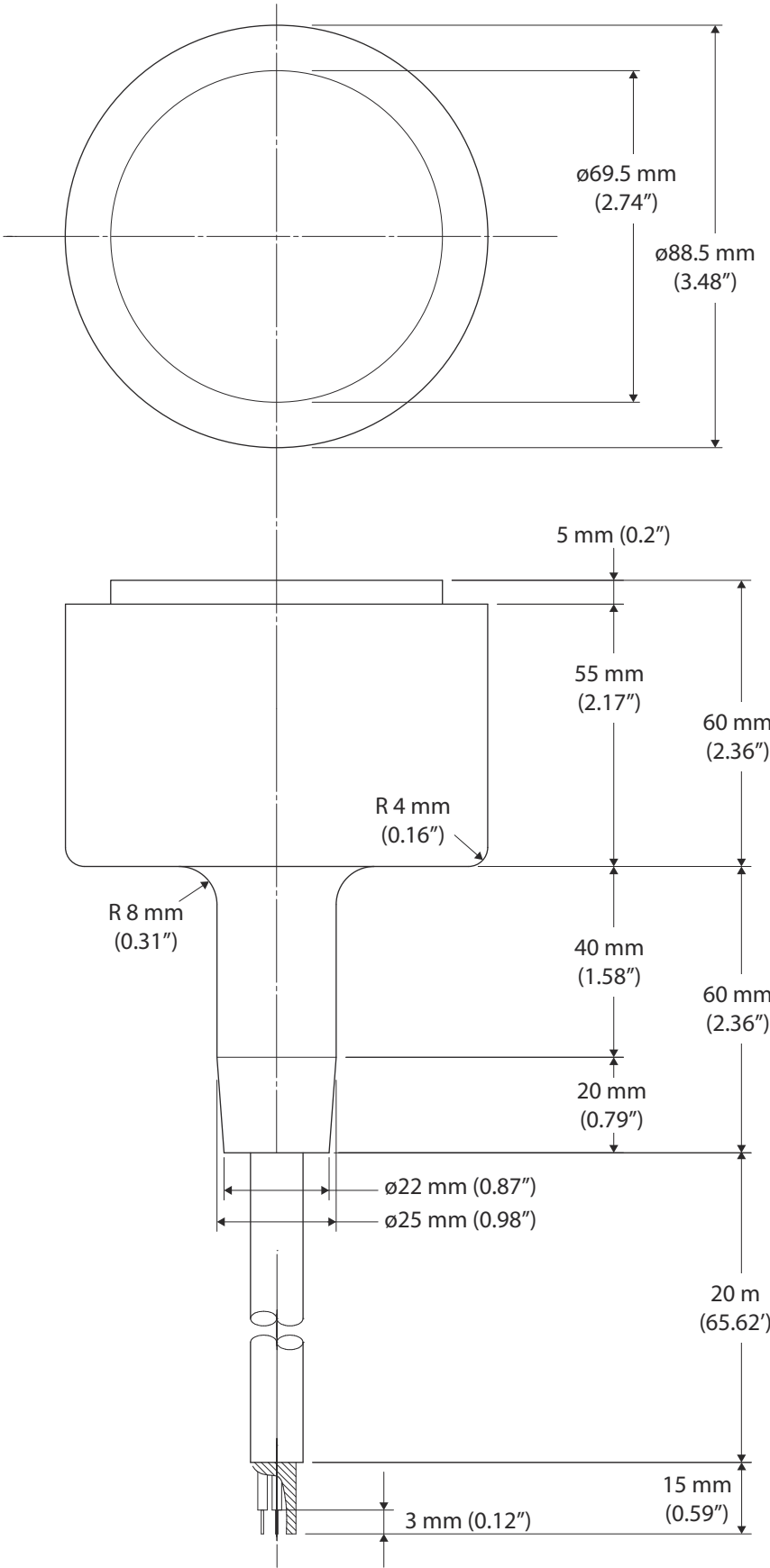

Supported data

→ **Note:** NMEA 0183 and NMEA 2000 data output requires the connection of relevant sensors.

NMEA 0183 sentences

Sentence	Description	In	Out
DBT	Depth Below Transducer	x	x
DPT	Depth	x	x
DSC	Digital Selective Calling Information	x	
DSE	Expanded Digital Selective Calling	x	
DTM	Datum reference	x	
GGA	Global positioning system (GPS) fix data	x	x
GLC	Geographic Position - Loran C		x
GLL	Geographic position- latitude and longitude	x	x
GNS	GNSS fix data	x	
GSA	GNSS DOP and Active Satellites	x	x
GSV	GNSS Satellites in view	x	x
HDG	Heading - Deviation & Variation	x	x
HDM	Heading - Magnetic	x	
HDT	Heading - True	x	
MOB	Man Over Board	x	
MTW	Water Temperature	x	x
MWD	Wind Direction and Speed	x	x
MWV	Wind Speed and Angle	x	x
OSD	Own ship data		x
RMC	Recommended Minimum Specific GNSS Data	x	x
RSD	Radar system data		x
RTE	Routes	x	
THS	True heading and status	x	
TLB	Target label		x
TLL	Target Latitude & Longitude		x
TTD	Tracked target data		x
TTM	Tracked target message		x
VBW	Dual ground/water speed	x	
VDM	AIS VHF data-link message	x	
VDO	AIS VHF data-link own vessel report	x	
VHW	Water speed and heading	x	x
VLW	Distance traveled through water	x	x
VTG	Course over ground and ground speed	x	x
WPL	Waypoint Location	x	
XDR	Transducer measurements	x	x
ZDA	Time and date	x	x

NMEA 2000 compliant PGN List

NMEA 2000 PGN (receive)

59392	ISO Acknowledgement
59904	ISO Request
60928	ISO Address Claim
126208	ISO Command Group Function
126992	System Time
126996	Product Info
127237	Heading/Track Control
127245	Rudder
127250	Vessel Heading
127251	Rate of Turn
127257	Attitude
127258	Magnetic Variation
127488	Engine Parameters, Rapid Update
127489	Engine Parameters, Dynamic
127493	Transmission Parameters, Dynamic
127503	AC input status
127504	AC Output Status
127505	Fluid Level
127506	DC Detailed Status
127507	Charger Status
127508	Battery Status
127509	Inverter Status
128259	Speed, Water referenced
128267	Water Depth
128275	Distance Log
129025	Position, Rapid Update
129026	COG & SOG, Rapid Update
129029	GNSS Position Data
129033	Time & Date
129038	AIS Class A Position Report
129039	AIS Class B Position Report
129040	AIS Class B Extended Position Report
129041	AIS aids to Navigation
129283	Cross Track Error
129284	Navigation Data
129539	GNSS DOPs
129540	AIS Class B Extended Position Report
129794	AIS aids to Navigation
129801	Cross Track Error
129283	Cross Track Error
129284	Navigation Data
129539	GNSS DOPs

129540	GNSS Sats in View
129793	AIS UTC & Date Report
129794	AIS Class A Static and Voyage Related Data
129798	AIS SAR Aircraft Position Report
129801	AIS Addressed Safety Related Message
129802	AIS Safety Related Broadcast Message
129808	DSC Call Information
129809	AIS Class B "CS" Static Data Report, Part A
129810	AIS Class B "CS" Static Data Report, Part B
130074	Route and WP Service - WP List - WP Name & Position
130306	Wind Data
130310	Environmental Parameters
130311	Environmental Parameters
130312	Temperature
130313	Humidity
130314	Actual Pressure
130576	Small Craft Status
130577	Direction Data
130578	Vessel Speed Components

NMEA 2000 PGN (transmit)

126208	ISO Command Group Function
126992	System Time
126996	Product Info
127237	Heading/Track Control
127250	Vessel Heading
127258	Magnetic Variation
128259	Speed, Water referenced
128267	Water Depth
128275	Distance Log
129025	Position, Rapid Update
129026	COG & SOG, Rapid Update
129029	GNSS Position Data
129283	Cross Track Error
129284	Navigation Data
129285	Route/Waypoint Data
129539	GNSS DOPs
129540	GNSS Sats in View
130074	Route and WP Service - WP List - WP Name & Position
130306	Wind Data
130310	Environmental Parameters
130311	Environmental Parameters
130312	Temperature
130577	Direction Data

Technical specifications

→ **Note:** The most up-to-date specifications list is available at: www.navico.com/commercial

Technical specification - S3009 Control unit

Connectivity	
Sonar	1 (1 kW RMS)
NMEA 2000	1 (NMEA 2000/IEC 61162-3)
NMEA 0183	2 (NMEA 0183/IEC 61162-1)
Ethernet	1
NMEA 0183 Sentences supported	See " <i>NMEA 0183 sentences</i> " on page 51
NMEA 2000 PGNs	See " <i>NMEA 2000 compliant PGN List</i> " on page 52
Display	
Type	9-inch diagonal, 480 x 800 pixel LCD
Backlighting	LED backlit, day/night brightness with 10 increments
Screen brightness	≥ 1200 cd/m ²
Viewing angles	160° horizontal, 110° vertical
Electrical	
Supply voltage	10.8 - 31.2 V DC
Power consumption - Max	12 W
Power consumption - Typical	11 W
Recommended fuse rating	3 A
Environmental	
Operating temperature range	-15°C (5°F) to +55°C (131°F)
Storage temperature	-25°C (-13°F) to +70°C (158°F)
Waterproof rating	IPx7
Humidity	Up to 95% at + 40°C (104°F)
Shock and vibration	According to IEC60945 ed 4.0 and RMS rules (2-020202-040-E Vol 2 Environmental Test of Equipment)
Physical	
Dimensions	See " <i>Dimensions - S3009 Control unit</i> " on page 49
Weight	1.95 kg (4.3 lbs)
Compass Safe Distance	0.4 m (1.31 feet)
Mounting type	Panel or bracket mount
Card reader	1 (SD card)

Technical specifications - TGM60-50-xxL transducer

Physical	
Dimensions	See " <i>Dimensions - TGM60-50-xxL and TGM50-200-xxL transducers</i> " on page 50
Weight	4.48 kg (9.88 lbs)
Number of wires	2 x 2,5/2,5 mm
Transducer	
Output	Depth
Frequency	50 kHz
Beam width	44°
Max depth	1 500 m (4 921 ft)
Speed	30 knots (35 mph)

Technical specifications - TGM50-200-xxL transducer

Physical	
Dimensions	See " <i>Dimensions - TGM60-50-xxL and TGM50-200-xxL transducers</i> " on page 50
Weight	2.09 kg (4.60 lbs)
Number of wires	2 x 2,5/2,5 mm
Transducer	
Output	Depth
Frequency	200 kHz
Beam width	11°
Max depth	400 m (1 312 ft)
Speed	30 knots (35 mph)



SIMRAD

